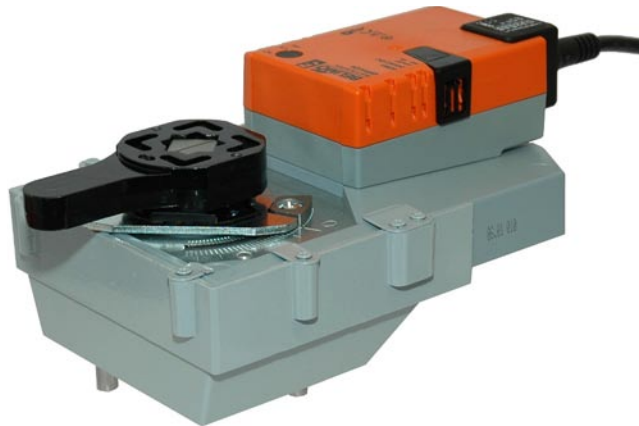

Rotary actuator for butterfly valves

- Torque 40 Nm
- Nominal voltage AC 100 ... 240 V
- Control: Open/close

Technical data

Electrical data	Nominal voltage	AC 100 ... 240 V, 50/60 Hz	
	Power supply range	AC 85 ... 265 V	
	Power consumption	In operation	2.5 W at nominal torque
		At rest	0.4 W
	For wire sizing	6 VA	
	Connection	Cable 1 m, 3 x 0.75 mm ²	
	Parallel connection	Possible, note performance data	
Functional data	Torque (nominal torque)	Min. 40 Nm @ nominal voltage	
	Manual override	Gearing latch disengaged with pushbutton (temporary-permanent)	
	Running time	150 s / 90° ↯	
	Noise level	Max. 45 dB (A) (without the valve)	
	Position indication	Mechanical, add-on	
Safety	Protection class	II Totally insulated <input type="checkbox"/>	
	Degree of protection	IP54 in any mounting position	
	EMC	CE according to 89/336/EEC	
	Low voltage directive	CE according to 73/23/EWG	
	Mode of operation	Type 1 (to EN 60730-1)	
	Rated impulse voltage	0.8 kV (to EN 60730-1)	
	Control pollution degree	3 (to EN 60730-1)	
	Ambient temperature range	0 ... +50 °C	
	Media temperature	-20 ... +100 °C in butterfly valve	
	Non-operating temperature	-40 ... +80 °C	
	Ambient humidity range	95% r.H., non-condensating (to EN 60730-1)	
	Maintenance	Maintenance-free	
Dimensions / Weight	Dimensions	See «Dimensions» on page 2	
	Weight	Approx. 1850 g	

Safety notes

- The rotary actuator has been designed for use in stationary heating, ventilation and air conditioning systems and is not allowed to be used outside the specified field of application, especially in aircraft or in any other airborne means of transport.
- Caution power supply voltage!
- It may only be installed by suitably trained personnel.
All applicable legal or institutional installation regulations must be complied with.
- The switch for changing the direction of rotation may only be operated by authorized personnel. The direction of rotation must not be reversed in a frost protection circuit.
- The device may only be opened at the manufacturer's site. It does not contain any parts that can be replaced or repaired by the user.
- The cable must not be removed from the device.
- The device contains electrical and electronic components and is not allowed to be disposed of as household refuse. All locally valid regulations and requirements must be observed.

Product features

- Simple direct mounting** Straightforward direct mounting on the butterfly valve with ISO 5211- F07 assembly flange. The mounting position in relation to the butterfly valve can be selected in 90° steps.
- High functional reliability** The actuator is overload-proof, requires no limit switches and automatically stops when the end stop is reached.
- ISO 5211 - F07 Butterfly valve D6..** For BELIMO F07 butterfly valve D6 and other dampers with the following mechanical specifications:
 - Square stem head (17 mm) for form-fit attachment of the rotary actuator.
 - Hole circle (d = 70 mm) for assembly with the butterfly valve.

Accessories

	Description	Data sheet
Electrical accessories	Auxiliary switch S..A..	T2 - S..A..
	Feedback potentiometer P..A..	T2 - P..A..

Electrical installation

Wiring diagram

Notes

- Caution power supply voltage.
 - Parallel connection of other actuators possible.
 - Direction of rotation switch is covered.
- Factory setting: Direction of rotation Y2



Direction
of rotation



Open-close control

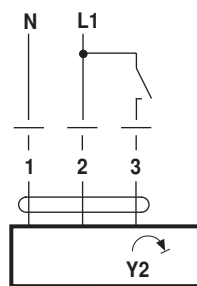

Rotary actuator	Rotary valve
Y2	A - AB = 0%

3-point control

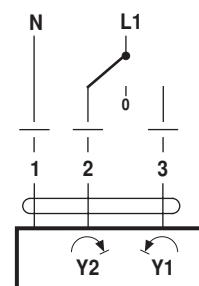

Dimensions [mm]

Dimensional diagrams

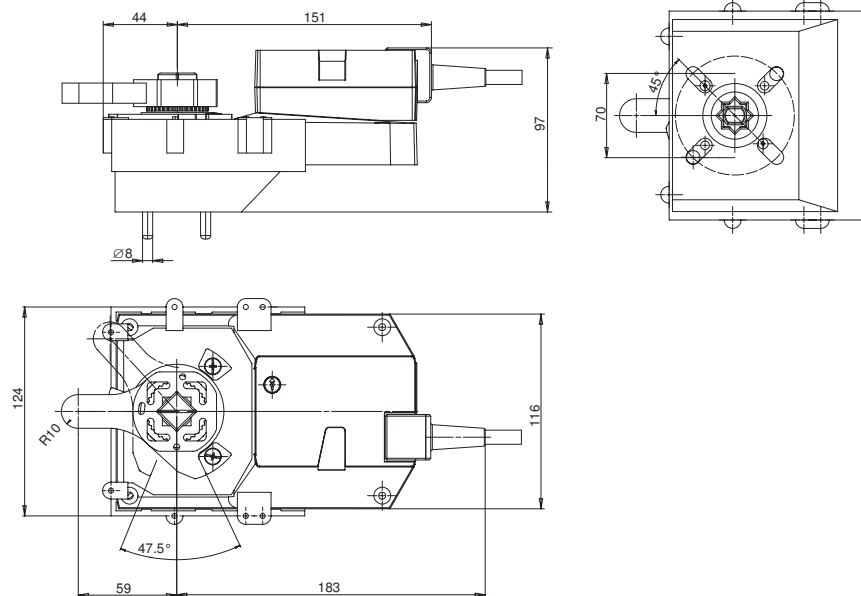

Further documentations

- Complete overview of actuators for water solutions
- Data sheets for butterfly valves
- Installation instructions for actuators and/or ball valves
- Notes for project planning (hydraulic characteristic curves and circuits, installation regulations, commissioning, maintenance etc.)