

Rotary actuator for  
2 and 3-way ball valves

- Torque 1.6 Nm
- Nominal voltage AC 24 V
- Control: Open/close or 3-point

**Technical data**

<b>Electrical data</b>	Nominal voltage	AC 24 V, 50/60 Hz
	Power supply range	AC 19,2 ... 28,8 V
	Power consumption	In operation 1 W at nominal torque For wire sizing 1 VA
	Connection	Cable 1 m, 3 x 0.75 mm <sup>2</sup>
	Parallel connection	No
<b>Funktionsdaten</b>	Torque (nominal torque)	Min. 1.6 Nm at nominal voltage
	Manual override	Temporary disengagement of gearing latch
	Running time	105 s / 90° ↯
	Noise level	Max. 35 dB (A)
	Position indication	Mechanical
<b>Safety</b>	Protection class	III Extra low voltage
	Degree of protection	IP40
	EMC	CE according to 89/336/EWG
	Mode of operation	Typ 1 (to EN 60730-1)
	Rated impulse voltage	0.8 kV (to EN 60730-1)
	Control pollution degree	3 (to EN 60730-1)
	Ambient temperature range	-7 ... +50°C
	Media temperature	+5 ... +100°C (in ball valve)
	Non-operating temperature	-40 ... +80°C
	Ambient humidity range	95% r.H., non-condensating (to EN 60730-1)
Maintenance	Maintenance-free	
<b>Dimensions / Weight</b>	Dimensions	See «Dimensions» on page 2
	Weight	Approx. 400 g (without ball valve)

**Sicherheitshinweise**

- The actuator has been designed for use in stationary heating, ventilation and air conditioning systems and is not allowed to be used outside the specified field of application, especially in aircraft or in any other airborne means of transport.
- It may only be installed by suitably trained personnel.  
All applicable legal or institutional installation regulations must be complied with.
- The device may only be opened at the manufacturer's site. It does not contain any parts that can be replaced or repaired by the user.
- The device contains electrical and electronic components and is not allowed to be disposed of as household refuse. All locally valid regulations and requirements must be observed.

## Product features

- Simple direct mounting** Straightforward direct mounting on the ball valve with only one screw. The mounting position in relation to the ball valve can be selected in  $90^\circ$  steps.
- Manual operation** Manual operation possible by lever (the gearing latch remains disengaged as long as the self-resetting lever is pressed).
- High functional reliability** The actuator switches off automatically when the end stops are reached.  
Pulse duration  $\geq 0.5$  s
- Combination valve actuators** Refer to the valve documentation for suitable valves, their permitted media temperatures and closing pressures.

## Electrical installation

### Wiring diagrams

**Note**  
Connect via safety isolation transformer.



### Open-close control

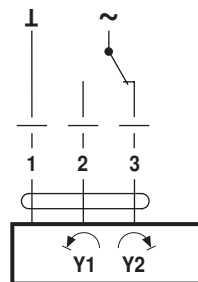

### 3-point control

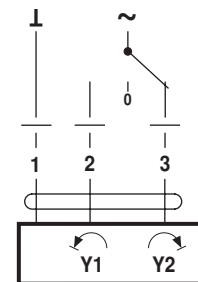

## Dimensions [mm]

### Dimensional diagrams

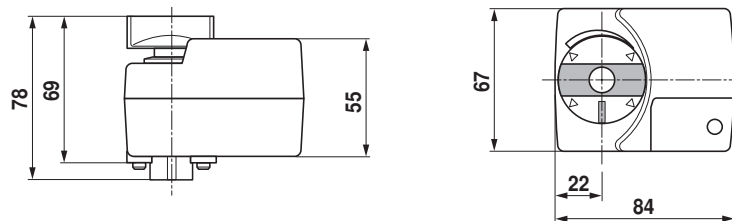

### Further documentations



- Complete overview of actuators for water solutions
- Data sheets for ball valves
- Installation instructions for actuators and/or ball valves
- Notes for project planning (hydraulic characteristic curves and circuits, installation regulations, commissioning, maintenance etc.)

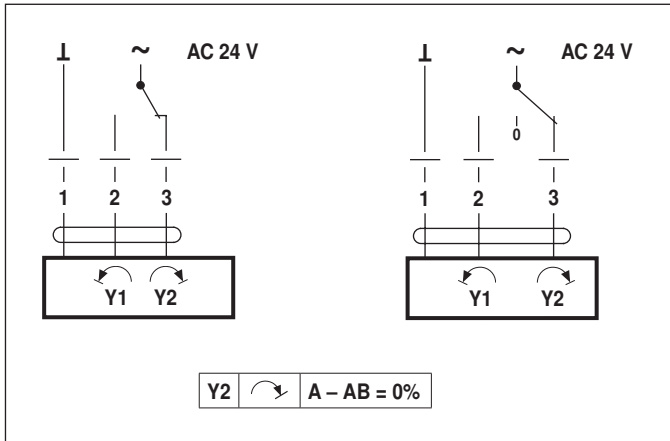
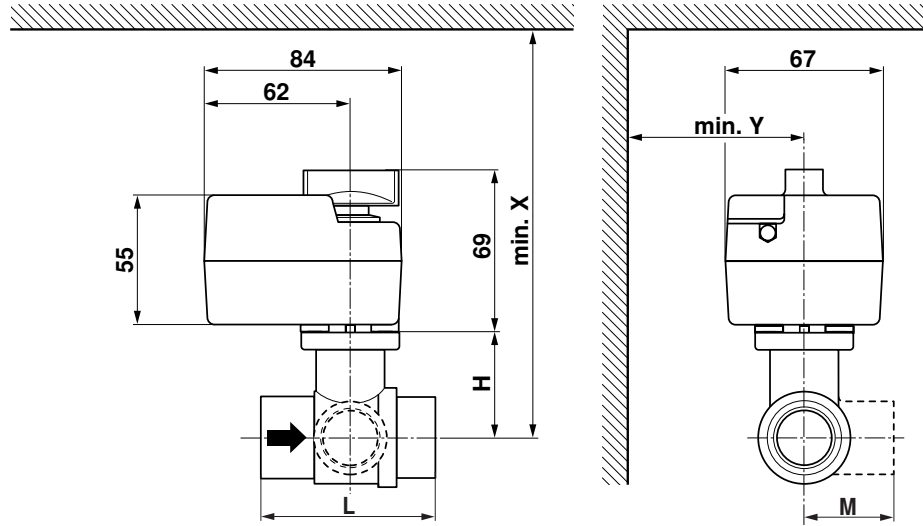

TRD24-3 (-T)  
TR24-3 (-T)

70631-00001.A



		DN		Rp	G	PN	mm			TRD24-3(-T)		TR24-3(-T)	
		mm	"	"	"		L	H	M	X	Y	X	Y
R2..K	R3..K	10	3/8	3/8			52	35	28	174	75		
R4..K	R5..K	10	3/8		3/4		69	31.5	34	171	75		
R2..	R3..	15	1/2	1/2			67	45	39			184	75
R4..	R5..	15	1/2		1		74	44	38			183	75
R6..R	R7..R	15	1/2			6	101.5	45	73			184	80

