



RedCos-P pressure sensor from 20 Pa...7.500 Pa

Electrical, explosion proof pressure or differential pressure sensor
24 VAC/DC supply voltage, 0 ... 10 V / (0)4 ... 20 mA analogue output
PTB-certified in acc. with ATEX directive EC/94/9 for zone 2, 22.

RedCos - P...
RedCos - P... - A

Subject to change!

Compact - Easy installation - Universal - Cost effective - Safe

Type	sensor	supply	range	min. range	max. pressure	output	Ex-i output	wiring
RedCos - P100	p, Δp	24 VAC/DC	+/- 100 Pa	20 Pa	25.000 Pa	(0) 4 .. 20 mA / 0 .. 10 V	-	SB 1.0
RedCos - P250	Druck-/Diff. Druck	24 VAC/DC	+/- 250 Pa	50 Pa	25.000 Pa	(0) 4 .. 20 mA / 0 .. 10 V	-	SB 1.0
RedCos - P500	Druck-/Diff. Druck	24 VAC/DC	+/- 500 Pa	100 Pa	50.000 Pa	(0) 4 .. 20 mA / 0 .. 10 V	-	SB 1.0
RedCos - P1250	Druck-/Diff. Druck	24 VAC/DC	+/- 1.250 Pa	250 Pa	50.000 Pa	(0) 4 .. 20 mA / 0 .. 10 V	-	SB 1.0
RedCos - P2500	Druck-/Diff. Druck	24 VAC/DC	+/- 2.500 Pa	500 Pa	50.000 Pa	(0) 4 .. 20 mA / 0 .. 10 V	-	SB 1.0
RedCos - P5000	Druck-/Diff. Druck	24 VAC/DC	+/- 5.000 Pa	1.000 Pa	75.000 Pa	(0) 4 .. 20 mA / 0 .. 10 V	-	SB 1.0
RedCos - P7500	Druck-/Diff. Druck	24 VAC/DC	+/- 7.500 Pa	1.500 Pa	120.000 Pa	(0) 4 .. 20 mA / 0 .. 10 V	-	SB 1.0
RedCos - P... - A	as above, but with additional intrinsically safe analogue output to connect an external digital indicator						(0) 4 .. 20 mA (Exi)	SB 3.0

Application

Pressure or differential pressure sensor

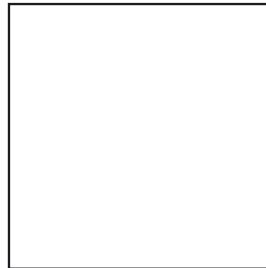
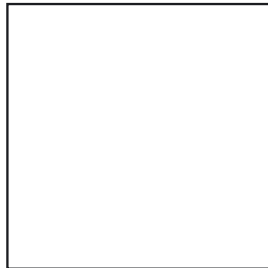

Accessory: external indicator Ex i

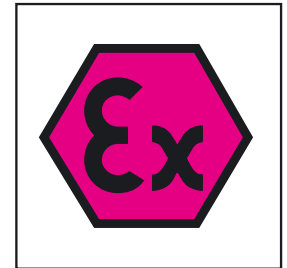

Description

The new **RedCos-P...** pressure sensor generation from +/- 100 Pa to +/- 7.500 Pa (acc. to type) is a revolution for differential pressure measuring in HVAC systems, in chemical, pharmaceutical, industrial and Offshore-/Onshore plants, for use in hazardous areas zone 2 (gas) and zone 22 (dust).

Highest protection class (ATEX) and IP 66 protection, small dimension, universal functions and technical data guarantee safe operation even under difficult environmental conditions.

The measuring ranges are scalable within the maximum ranges. At RedCos-P100 the smallest ΔP range is 20 Pa. The analogue output signal is either 0...10 VDC or 4...20 mA and can be selected on site. The integrated display is for actual value indication which can be switched off.

All sensors are programmable on site without any additional tools.

RedCos-P...-A sensors are additionally equipped with a 4 ... 20 mA IS (IS = intrinsically safe) output, e.g. for an external indicator.

Highlights

- ▶ For all type of gas, mixtures, vapours and dust for use in zone 2 and 22
- ▶ Integrated junction box
- ▶ Power supply 24 VAC/DC
- ▶ Display with backlight, can be switched off
- ▶ Scalable analogue output, selectable 0...10 V / (0) 4...20 mA
- ▶ Compact design and small dimension (L x W x H = 177 x 107 x 66 mm)
- ▶ Robust aluminium housing in protection class IP 66
- ▶ Down to -20°C ambient temperature applicable
- ▶ Password locking
- ▶ Optional IS-output (4 .. 20 mA) for external indicator in Ex-areas



Technical data	RedCos - P...
Power supply	24 VAC/DC +/- 20% (19,2 ... 28,8 VAC/DC) 50...60 Hz
Current, power consumption	150 mA, ~ 4 W, internal fuse 500 mA, without bracket, not removable
Galvanic isolation	supply - analogue output 1,5 kV (Ex 60 V)
Electrical connection	terminals 0,14 ... 2,5 mm ² at integrated junction box
Cable entry	M16x1,5 cable diameter ~ Ø 5...10 mm
Protection class	Class I (grounded)
Display	2 x 16 digits, dot-matrix with backlight, display for configuration, user guidance, parameter and actual value indication
Control elements	3 buttons for configuration
Housing protection	IP66 in acc. to IEC 60529
Housing material	aluminium casting, coated
Dimension / weight	L x W x H = 177 x 107 x 66 mm / ~ 950 g
Ambient temperature/-humidity	- 20 ... + 50 °C / 0 ... 95 % rH, non condensed
Storage temperature	- 40 ... + 70 °C
Measuring range	+/- 100 Pa, +/- 250 Pa, +/- 500 Pa, +/- 1.250 Pa, +/- 2.500 Pa, +/- 5.000 Pa, +/- 7.500 Pa in acc. to type
Range scalable on site	minimum measuring range is 10 % of full range (e.g. 20 Pa @ +/- 100 Pa sensor)
Maintenance	maintenance free, nevertheless maintenance must be complied with regional standards, rules and regulations
Sensor circuit	internal IS circuit
Sensor	Piezo-pressure-transmitter
Pressure connection	P+ / P- sleeves Ø 4 ... 6 mm
Response time of sensor	T90 / 5 Sec.
Accuracy of pressure	± 2 % of end value +/- 1 Pa
Non linearity and hysteresis	± 0,05 % typically , max. 0,25 % of end value
Start delay	5 s
Setting zero point	via menu, mechanical short circuit of P+ / P- for the moment of zero point setting
Stability	long term stability < 0,2 %/year, temperature influence < 0,02 %/K, supply voltage influence < 0,01 %
Output	voltage U(V) or current I(mA) selectable via menu on site
Output protection	against short circuit and external voltage up to 24 V, protected against polarity reversal
Voltage output U	from 0...10 VDC adjustable, invertible, burden > 1 kΩ, influence < 0,05% / 100 Ω
Current output I	from 0...20 mA adjustable, invertible, burden < 500 Ω, influence < 0,1% / 100 Ω, open circuit voltage < 24 V
Output at alarm mode	increasing or decreasing output signal, selectable on site, down to 0 VDC/0 mA or up to 10 VDC/20 mA
Wiring diagram (SB)	SB 1.0
Delivery (changeable on site)	min. / max. pressure range limits (e.g. RedCos-P100 = -100 ... 100 Pa), output 4 ... 20 mA, output with decreasing alarm situation to 0V/0mA
Included in delivery	RedCos-P... with 3 screws 4,2x13 self-tapping and short circuit tube, ~ 140 mm length
Installation sensor / tubing	in Ex-area zone 2, 22

Additional information for RedCos-P...-A:

Analogue output	(0) 4...20 mA
Ex i	Intrinsically Safe (IS)
Burden	max. 400 Ω
Accuracy	± 0,5 %
Plug	cable diameter Ø 6...8 mm
Delivery version ...-P-A	incl. 1 x plug

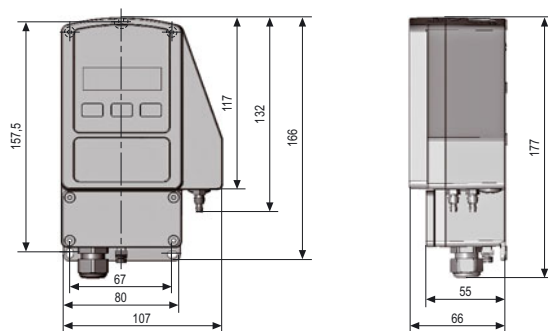
Dimensions / Drillings

Explosion proof	RedCos-P...
PTB-testet	PTB 08 ATEX 2003
acc. to ATEX directive	RL 94/9/EC (ATEX)
Approval for gas	II(3)G Ex nC [ia] IIC T6 for zone 2
Approval for dust	II(3)D Ex tD A22 [iaD] IP66 T80 °C for zone 22
Identification	CE Nr. 0158
EMC	89/336/EC EMC directive
Low voltage	73/23/EC low voltage directive
Protection type	IP 66 in acc. to EN 60529
Potential compensation	external PA-terminal, 4 mm ²

Accessories

EXC-RIA-261	LCD indicator (IS), installation in Ex-areas zones 1, 2, 21, 22, connectable direct to RedCos-... sensorees with type RedCos-P.- A
MKR	Mounting bracket for round ducts up to Ø 600 mm
Kit 2	consists of 2 m flexible pressure tube Ø 6 mm, 2 connection nipples

Electrical connection

RedCos-P... sensors required a 24 VAC/DC power supply. The supply has to be connected at terminal 1 (-/-) and 2 (+/+), the analogue output at terminal 3 (mA/V) and 4 (GND). The electrical wiring must be realized via integrated junction box.

Attention! Before opening the junction box cover, the supply voltage must be shut off! The optional analogue output at RedCos-P...-A is intrinsically safe. Note the maximum connection values of intrinsically safe parameters (see table below).

Zero point compensation for pressure transmitter

RedCos-P... pressure sensor is equipped with a zero point compensation, to adjust the module to the installation position. The pressure nipples **P+** / **P-** must be connected with a short circuit tube. To make compensation please follow the menu. In menu point 18 zero point compensation is done by push button. Before starting the zero point compensation, the device should be connected to the power supply for minimum of 15 minutes, to reach the working temperature!

Wiring Diagram RedCos-P...

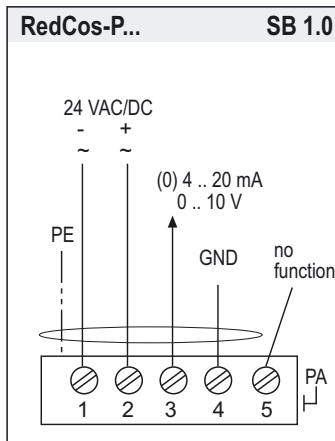

Display and Buttons

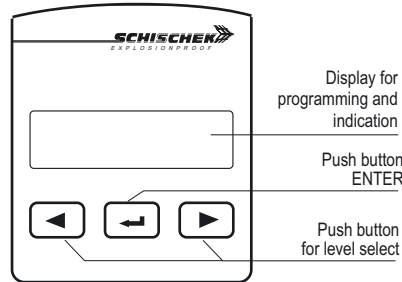

Change operation- / parametrisation mode

To change from operation to parametrisation mode and vice versa, push the enter button for minimum 3 seconds.

Indication of data logging

A blinking star in the display shows that data is received and the device is working.

Wiring Ex i (IS) output (optional) at RedCos-P...A

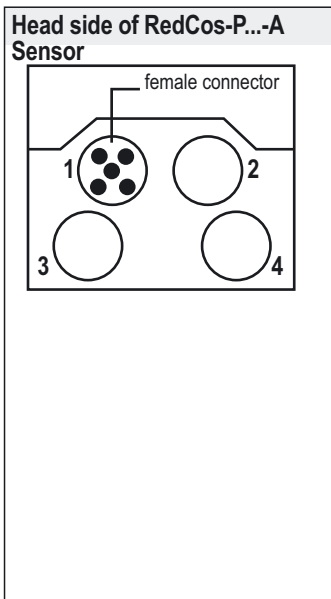
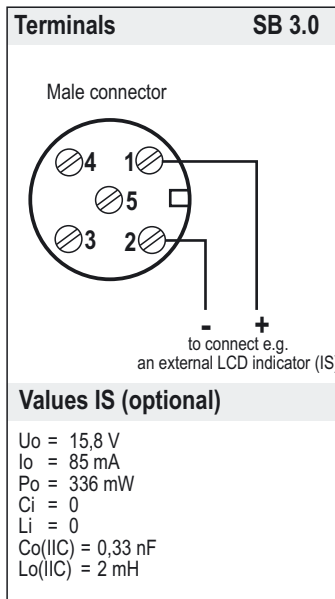

Password input

The default / delivery setup is 0000. In this configuration the password input is not activated. To activate a password, go to menu point 20, change the 4 digits into your chosen numbers (e.g. 1234) and press Enter.

Please keep your password in mind for next parameter change!

Due to a new parameter setup the password is requested.

Important information for installation and operation

A. Installation, Commissioning, Maintenance

The cable has to be drawn through the cable gland. After electrical connection the cable gland must be fixed tight. IP66 must be fulfilled.

In acc. with operation RedCos sensors are maintenance free. Nevertheless maintenance must comply with regional standards, rules and regulations.

The sensors must not be opened by the customer. For outdoor installation a protective housing against rain, snow and sun should be applied. For electrical connection use the internal junction box.

Attention: Note the explosion proof rules before opening the internal junction box. Cut off the power supply.

B. Pressure sensors

After mounting and installation, a zero point compensation must be done, because the offset value depends on the installation position. Have a look to parametrisation.

C. Long cabling

For using long signal wires, shielded cables are recommended. The shield must be connected to the RedCos-P sensor inside the terminal box.

D. Separate ground wires

Use for supply and signal wires a separate ground.

Values intrinsically safe (IS) pressure sensor

Internal sensor values	
U ₀ = 7,9 V	Internal sensor IS values are corresponding to the internal pressure sensor. Due to the matter of fact that there is no external sensor connected, these IS values are not relevant for the customer but shown for the sale of completeness.
I ₀ = 48 mA	
P ₀ = 95 mW	
C _i = 0	
L _i = 0	
Co (IIC) = 1,3 nF	
Lo (IIC) = 2 mH	

Parametrisation and commissioning of RedCos-P(-A) transducers

Preparation of parametrisation/operation

Operation ↔ Parametrisation, push  for 3 sec.

If password (PW) protection is active: put PW in, push 















































































Change operation- / parametrisation mode

To change from operation to parametrisation mode push "enter button"  for minimum 3 seconds. Back over the menu save and exit.

Example

Menu language english
Range -25...+25 Pa
Output 4...20 mA
Output Ex-i 4...20 mA

Menu	Function	Enter	Indication	Select	Enter	Next indication	Next selection	Enter	Next menu
Menu 1	DE, EN, FR select language: german, english, french		DE, EN, FR english	 					
Menu 2	no function - menu skip								
Menu 3	no function - menu skip								
Menu 4	unit sensor select physical unit		unit sensor Pa	 					
			Pa, mbar, inH2O						
Menu 5	range adjust the measuring range		range -25..100 Pa	 		range -25..25 Pa	 		
			↑ adjust lower limit			↑ adjust higher limit			
Menu 6	no function - menu skip								
Menu 7	output V, mA select output signal as VDC or mA		output V mA mA	 					
			mA / V						
Menu 8	output range adjust the output range		output range 4..20mA	 		output range 4..20mA	 		
			↑ adjust lower limit			↑ adjust higher limit			
Menu 9	sensor error select signal at sensor error		sensor error 10V / 20 mA	 					
			10V / 20 mA oder 0V / 0mA						
Menu 10	output   select if signal output is increasing or decreasing		output   increasing	 					
			 increasing, decreasing						
Menu 11	no function - menu skip								
Menu 12	no function - menu skip								
Menu 13	no function - menu skip								
Menu 14	no function - menu skip								
Menu 15	no function - menu skip								
Menu 16	output Ex (option, only at RedCos-P-A) adjust 4...20 mA or 0...20 mA IS output signal		output Exi 4..20 mA	 		output Exi 4..20 mA	 		
			↑ adjust lower limit			↑ adjust higher limit			
Menu 17	no function - menu skip								
Menu 18	zero point compensation after short circuit the pressure nipples P+ / P- the sensor gets a zero point calibration.		set zero point yes no	 					
Menu 19	display function select display on/off, illuminated or backlight off		display function on illuminated	 					
			on illuminated, on, off						
Menu 20	password select password protection		new password yes no	 		password 0000	 		
Menu 21	save and exit select save data / factory setting / discard or back to menu		save and exit save data	 					
Menu 22	Set offset Add / subtract from measures value		set offset 0.00Pa	 					
Menu 23	no function - menu skip								