

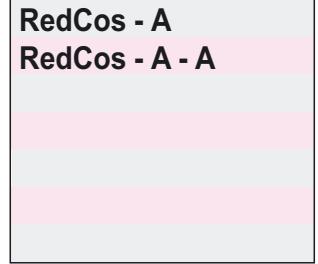

# RedCos-A transducer for passive sensors

Electrical, explosionproof transducer only connectable for passive sensors  
Pt 100, Pt 500, Pt 1000, Kd 250, Ni 100, Ni 200, Ni 500,  
Ni 1000, Ni 1000 Siemens, Potentiometer  
24 VAC/DC supply, 0...10 V / (0) 4...20 mA output  
PTB-certified in acc. with ATEX directive EC/94/9 for zone 1, 2, 21, 22.



Subject to change!

## Transducer

Type	supply	installation area	connectable sensors	function of sensors	sensor connection	wiring
RedCos - A	24 VAC/DC	zone 1, 2, 21, 22	PT100, PT1000, Ni100, ...	°C, %rH, combination °C/%rH	via plug - and - socket connection	SB 1.0
RedCos - A - A	as above, but with additional intrinsically safe analogue output to connect an external digital indicator(0) 4...20 mA (Exi)					SB 3.0

## Applicaton

### RedCos-A... transducer

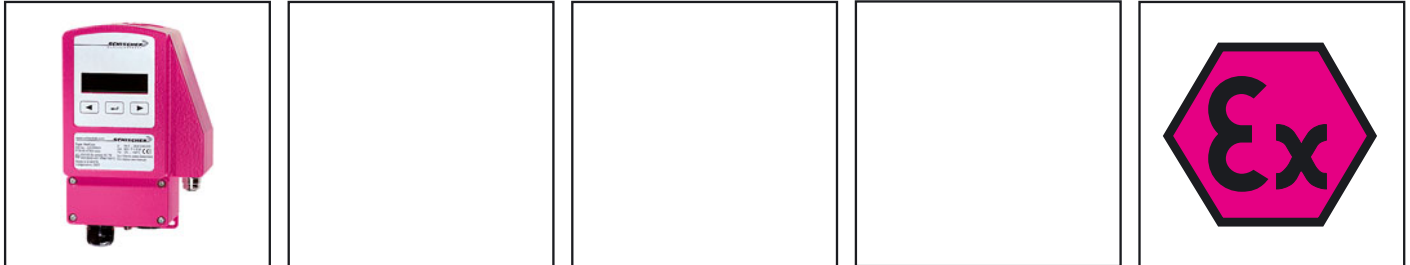

## Description

The new **RedCos-A...** transducer generation with direct connectable passive sensors are a revolution for measuring temperature or humidity in HVAC systems, in chemical, pharmaceutical, industrial and Offshore-/Onshore plants, for use in hazardous areas zone 1, 2 (gas) and zone 21, 22 (dust).  
Highest protection class (ATEX) and IP 66 protection, small dimension, universal functions and technical data guarantee safe operation even under difficult environmental conditions.  
The measuring ranges are scalable within the maximum ranges. The analogue output signal is either 0...10 VDC or 4...20 mA and can be selected on site. The integrated display is for actual value indication which can be switched off.  
All sensors are programmable on site without any additional tools.  
**RedCos-A-A** transducer are additionally equipped with a 4...20 mA IS (IS = intrinsically safe) output, e.g. for an external indicator.

## Highlights transducer

- ▶ For all type of gas, mixtures, vapours and dust for use in zone 1, 2, 21 and 22
- ▶ No additional Ex-i module required
- ▶ No intrinsically safe wiring/installation between panel and sensor required
- ▶ No intrinsically safe wiring/installation and no space in the panel required
- ▶ Integrated Ex-e junction box
- ▶ Power supply 24 VAC/DC
- ▶ Display with backlight, can be switched off
- ▶ Scalable analogue output, selectable 0...10 V / (0) 4...20 mA
- ▶ Compact design and small dimension (L x W x H = 177 x 107 x 66 mm)
- ▶ Robust aluminium housing in protection class IP 66
- ▶ Down to -20°C ambient temperature applicable
- ▶ Password locking
- ▶ Optional IS-output (4...20 mA) for external indicator in Ex-areas

Technical data	RedCos-A...
Power supply	24 VAC/DC +/- 20% (19,2 ... 28,8 VAC/DC) 50...60 Hz
Current, power consumption	150 mA, ~ 4 W, internal fuse 500 mA, without bracket, not removable
Galvanic isolation	supply - analogue output 1,5 kV (Ex 60 V)
Electrical connection	terminals 0,14 ... 2,5 mm <sup>2</sup> at integrated junction box
Cable entry	M16x1,5, cable diameter ~ Ø 5...10 mm
Protection class	Class I (grounded)
Display	2 x 16 digits, dot-matrix with backlight, display for configuration, user guidance, parameter and actual value indication
Control elements	3 buttons for configuration
Housing protection	IP66 in acc. to IEC 60529
Housing material	aluminium casting, coated
Dimension / weight	L x W x H = 177 x 107 x 66 mm / ca. 950 g
Ambient temperature/humidity	20 ... + 50 °C / 0 ... 95 % rH, non condensed
Storage temperature	- 40 ... + 70 °C
Sensor connection	only for passive sensors via plug-and-socket connection at front side of the transducer.
Measuring range	measuring ranges are scalable within the maximum measuring range
Maintenance	maintenance free, nevertheless maintenance must be complied with regional standards, rules and regulations
Start delay	5 sec.
Accuracy	± 0,4 % of end value + probe accuracy
Non linearity and hysteresis	± 0,10 %
Stability	long term stability < 0,2 % / year, temperature influence < 0,02 %/K, supply voltage influence < 0,01 %
Output	voltage U(V) or current I(mA) selectable via menu on site
Output protection	against short circuit and external voltage up to 24 V, protected against polarity reversal
Voltage output U	from 0...10 VDC adjustable, invertible, burden > 1 kΩ, influence < 0,05% / 100 Ω
Current output I	from 0...20 mA adjustable, invertible, burden < 500 Ω, influence < 0,1% / 100 Ω, open circuit voltage < 24 V
Output at alarm mode	increasing or decreasing output signal, selectable on site, down to 0 VDC/0 mA or up to 10 VDC/20 mA
Wiring diagram (SB)	SB 1.0
Delivery (changeable on site)	output 4 ... 20 mA, output with decreasing alarm situation to 0V/0mA
Included in delivery	RedCos-A... with 3 screws 4,2x13 self-tapping
Installation area transducer	in Ex-area zone 1, 2, 21, 22

**Additional information for RedCos-A-A:**

Analogue output	(0) 4...20 mA
Ex i	Intrinsically Safe (IS)
Burden	max. 400 Ω
Accuracy	± 0,5 %
Plug	cable diameter Ø 6...8 mm
Delivery version ...-A-A	incl. 1 x plug

**Dimensions / Drillings**

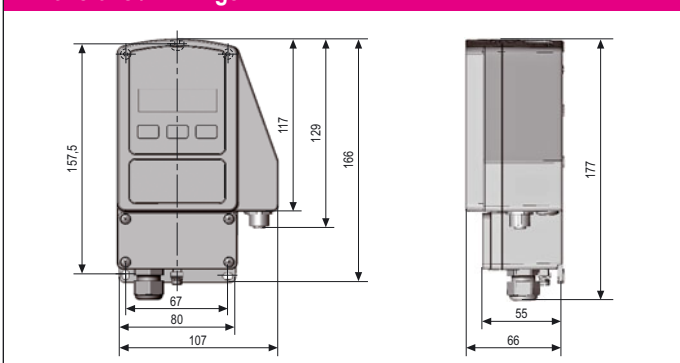

Explosion proof	RedCos-...
PTB-testet	PTB 08 ATEX 2003
acc. to ATEX directive	RL 94/9/EC (ATEX)
Approval for gas	II(1)G Ex nC [ia] IIC T6 for zone 2
Approval for dust	II(1)D Ex tD A22 [iaD] IP66 T80°C for zone 22
Identification	CE Nr. 0158
EMC	89/336/EC EMC directive
Low voltage	73/23/EC low voltage directive
Protection type	IP 66 in acc. to EN 60529
Potential compensation	external PA-terminal, 4 mm <sup>2</sup>

Accessories	
<b>EXC-RIA-261</b>	LCD indicator (IS), installation in Ex-areas zones 1, 2, 21, 22, connectable direct to RedCos-... sensors with type RedCos-P.- A
<b>MKR</b>	Mounting bracket for round ducts up to Ø 600 mm



Electrical wiring

RedCos-A... sensors required a 24 VAC/DC power supply. The supply has to be connected at terminal 1 (-/-) and 2 (+/-), the analogue output at terminal 3 (mA/V) and 4 (GND). The electrical wiring must be realized via junction box.

Attention! Before opening the junction box cover, the supply voltage must be shut off! The optional analogue output at RedCos-A-A is intrinsically safe. Note the maximum connection values of intrinsically safe parameters (see table below).

Wiring diagram RedCos-A... supply and analogue output

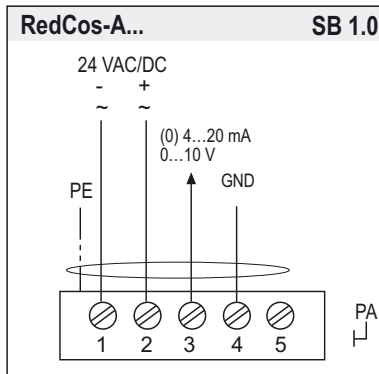

Wiring passive sensors

Connect the wires max. 0,75 mm² are acc. to diagram. After than close threat tighten The cable diameter has to be between 6-8 mm.

Connectable sensors are:

Pt 100, Pt 500, Pt 1000, Kd 250

Ni 100, Ni 200, Ni 500, Ni 1000, Ni 1000 Siemens

resistor 0 - 1 kOhm, 0 - 10 kOhm

potentiometer 0 - 1 kOhm, 0 - 10 kOhm

Connention temperatur probe and resistor

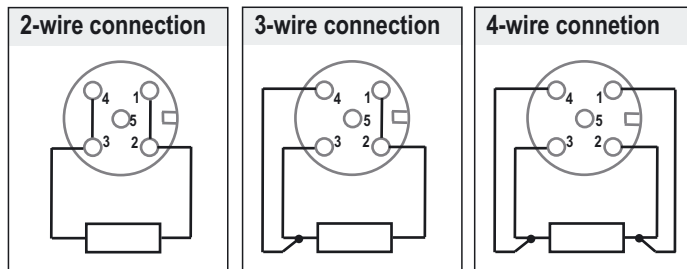

Connention potentiometer

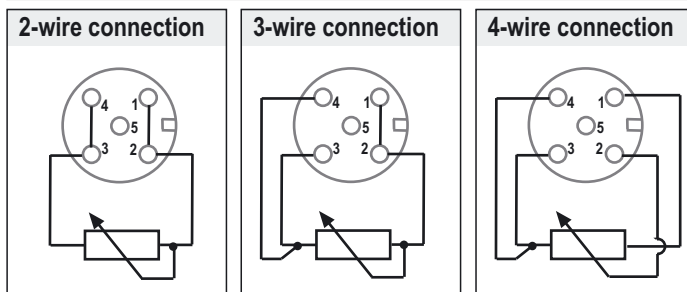

Values intrinsically safe (IS) for passive sensors

Uo = 7,9 V
Io = 6,4 mA
Po = 12,7 mW
Ci = 0
Li = 0
Co (IIC) = 1,4 nF
Lo (IIC) = 2 mH

Wiring Ex i output (optional) at RedCos-A-A transducer

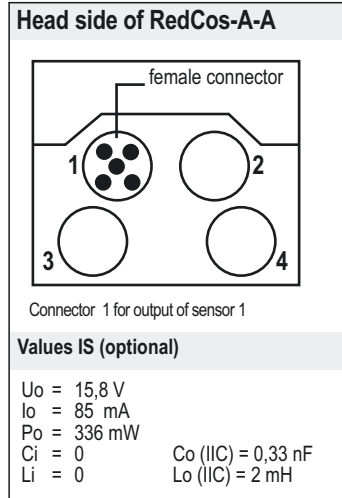
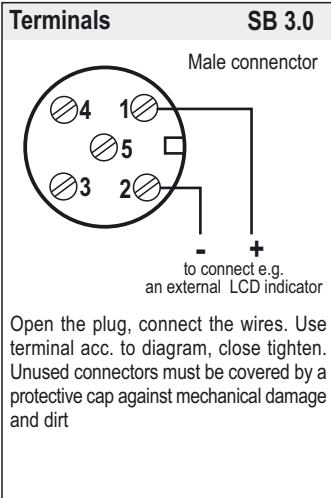

Parameter

Before starting parametrisation of RedCos-A... transducer a passive sensor must be connected. In acc. with the sensor type you need to set parameter.

Display and Buttons

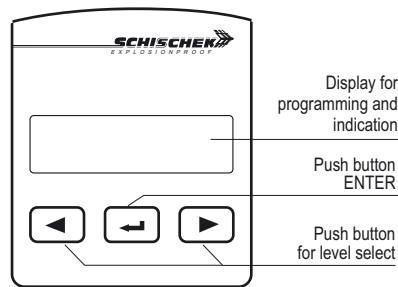

Indication of data logging

A blinking star in the display shows that datas received and the device is working.

Umschaltung Betriebs- /Parametriemodus

To change from operation to parametrisation mode push "enter button" for minimum 3 seconds.

Password input

The default / delievery setup is 0000. In this configuration the password input is not activated. To activate a password, go to menu point 20, change the 4 digits into your choosen numbers (e.g. 1234) and press Enter.

Please keep your password in mind for next parameter change!

Due to a new parameter setup the password is requested.

Important information for installation and operation

A. Installation, Commisioning, Maintenance

The cable has to be drawn through the cable gland. After electrical connection the cable gland must be fixed tighten. IP66 must be fulfilled.

In acc. with operation RedCos sensors are maintenance free. Nevertheless maintenace must comply with regional standards, rules and regulations.

The sensors must not be opened by the customer. For outdoor installation a protective housing against rain, snow and sun should be applied. For electrical connection use the internal approved Ex-e junction box.

Attention: Note the explosion proof rules before opening the internal junction box. Cut off the power supply.

B. Long cabling

For using long signal wires, shielded cables are recommended. The shield must be connected to the RedCos-P sensor inside the terminal box.

C. Separate ground wires

Use for supply and signal wires a separate ground.

**Parametrisation and commissioning of RedCos-A(-A) transducers after connection the passive sensor**

**Preparation of parametrisation/operation**

Operation ↔ Parametrisation, push  for 3 sec.

If password (PW) protection is active: put PW in, push 



































































































**Change operation- / parametrisation mode**

To change from operation to parametrisation mode push "enter button"  for minimum 3 seconds. Back over the menu save and exit.

**Example**

**Menu language** english  
**Sensor** PT100 / 3 wire  
**Range** 0...+50°C,  
**Output** 0...10 VDC  
**Output Ex-i** 4...20 mA

Menu	Function	Enter	Indication	Select	Enter	Next indication	Next selection	Enter	Next menu
Menu 1	DE, EN, FR select language: german, english, french		DE, EN, FR english deutsch, english, francais	 					
Menu 2	type of sensor select sensor type		type of sensor PT100 PT100, PT500, PT1000, NI100, .....	 					
Menu 3	2-3-4 wire 2-3-4 wire connection		2-3-4 wire 3-wire	 					
Menu 4	Unit sensor select physical unit		unit sensor °C °C, °F	 					
Menu 5	range adjust the measuring range		range 0..50 °C ↑ adjust lower limit	 		range 0..50 °C ↑ adjust higher limit	 		
Menu 6	display range * * only active at resistor and potentiometer		display range 0..50 °C ↑ adjust lower limit	 		display range 0..50 °C ↑ adjust higher limit	 		
Menu 7	output V, mA select output signal as VDC or mA		output V mA V mA / V	 					
Menu 8	output range adjust the output range		output range 0..10V ↑ adjust lower limit	 		output range 0..10V ↑ adjust higher limit	 		
Menu 9	sensor error select signal at sensor error		sensor error 10V / 20 mA 10V / 20 mA or 0V / 0mA	 					
Menu 10	output   select if signal output is increasing or decreasing		output   increasing   increasing, decreasing	 					
Menu 11	no function - menu skip								
Menu 12	no function - menu skip								
Menu 13	no function - menu skip								
Menu 14	no function - menu skip								
Menu 15	no function - menu skip								
Menu 16	output Ex (option, only at RedCos-A-A) adjust 4...20 mA or 0...20 mA IS output signal		output Exi 4..20 mA ↑ adjust lower limit	 		output Exi 4..20 mA ↑ adjust higher limit	 		
Menu 17	no function - menu skip								
Menu 18	no function - menu skip								
Menu 19	display function select display on/off, illuminated or backlight off		display function on illuminated on illuminated, on, off	 					
Menu 20	password select password protection		new password yes no	 		password 0000	 		
Menu 21	save and exit select save data / factory setting / discard or back to menu		save and exit save data	 					
Menu 22	Set offset Add / subtract from measures value		set offset 0.00°C	 					
Menu 23	no function - menu skip								